

# CASTLEROK®

## PALLET OVERVIEW

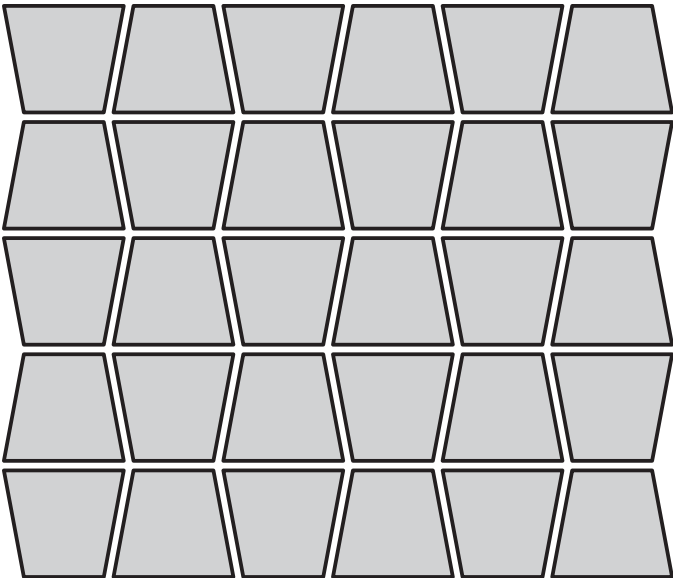

90 units / pallet  
 22.5 sq. ft. / pallet  
 3 layers / pallet  
 1,710 lbs. / pallet

## SPECIFICATIONS



9" - 6" x 8" x 4"  
 19 lbs. / unit  
 4 units / sq. ft.

## LAYING PATTERNS

**FIRE PIT:** 30" inside diameter fire pit uses 68 Castlerok units (17 units per row / 4 rows)

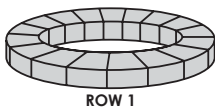

ROW 1

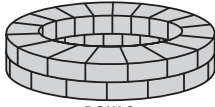

ROW 2

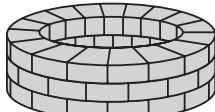

ROW 3

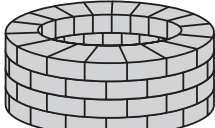

ROW 4

*This pit is designed to fit a 30" Carbon Steel Insert*

- Curved wall using Castlerok

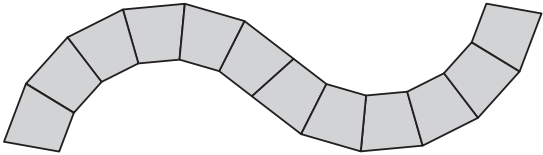

- Curved wall using Castlerok & Country Stone

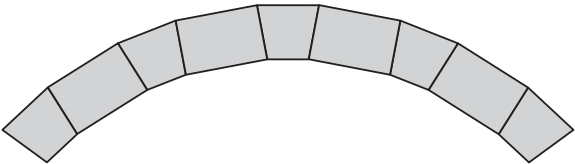

## NOTES



DRY-CAST  
 WARRANTY

## CAP OPTIONS



DOUBLE  
 BULLNOSE CAPS

## APPLICATIONS



OUTDOOR  
 LIVING



WALLS &  
 COLUMNS

COLOR SWATCHES AVAILABLE AT LAMPUS.COM • ALL WEIGHTS ARE APPROXIMATE

# COUNTRY STONE

## PALLET OVERVIEW

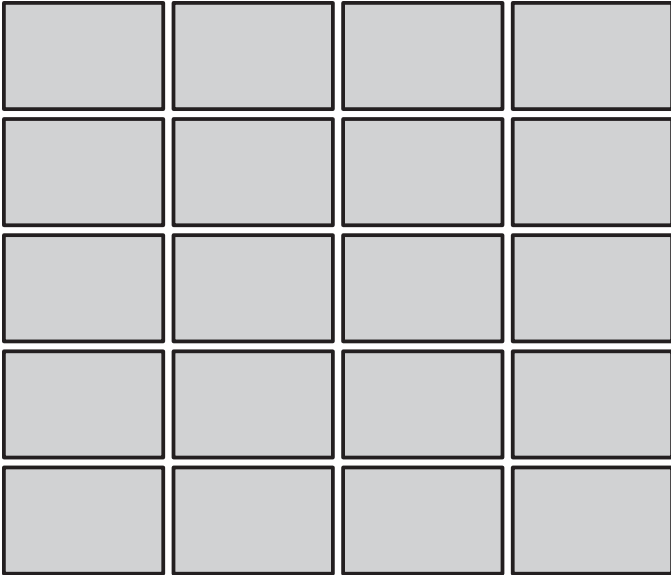

60 units / pallet  
17 sq. ft. / pallet  
3 layers / pallet  
1,860 lbs. / pallet

## SPECIFICATIONS



12" x 8" x 4"  
31 lbs. / unit  
3 units / sq. ft.  
*(per typical installation)*

## LAYING PATTERNS

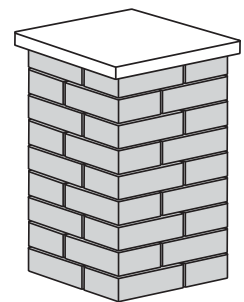
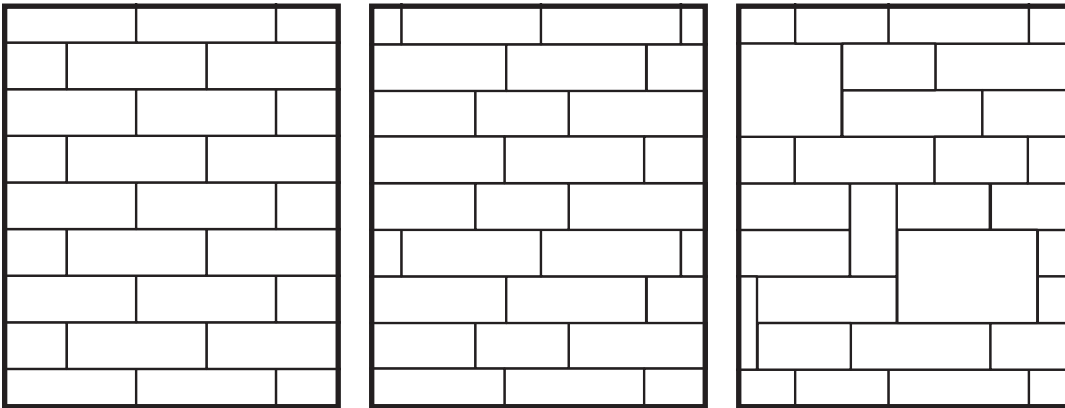

20" x 20" x 36" Column  
4 block / layer  
9 layers / column  
24" x 24" Column Cap on top

## NOTES



DRY-CAST  
WARRANTY

## CAP OPTIONS



DOUBLE  
BULLNOSE CAPS



LIMESTONE  
COLUMN CAPS

## APPLICATIONS



OUTDOOR  
LIVING



WALLS &  
COLUMNS

COLOR SWATCHES AVAILABLE AT [LAMPUS.COM](http://LAMPUS.COM) • ALL WEIGHTS ARE APPROXIMATE

# ROSETTA® GRAND LEDGE

## PALLET OVERVIEW

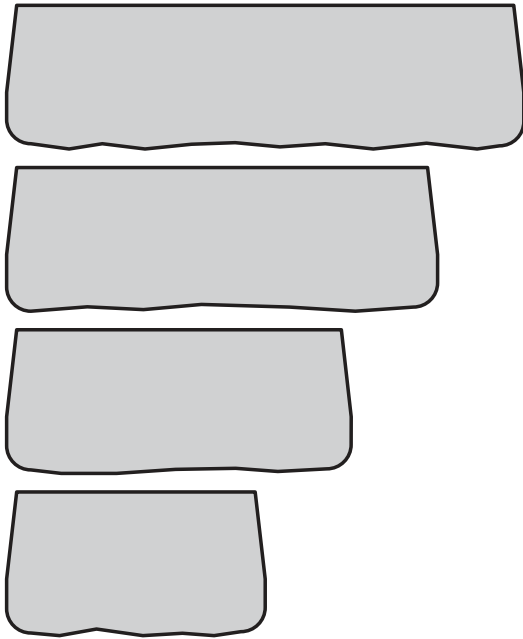

4 units / pallet  
18 sq. ft. / pallet  
4,000 lbs. / pallet  
24 unique textures

## SPECIFICATIONS



72" x 20" x 12"  
1,350 lbs. / unit  
1 unit / pallet



60" x 20" x 12"  
1,080 lbs. / unit  
1 unit / pallet



48" x 20" x 12"  
890 lbs. / unit  
1 unit / pallet



36" x 20" x 12"  
660 lbs. / unit  
1 unit / pallet

*Setback/Batter = 2 1/4" per 12"  
Wall blocks have a 3 1/4" taper (1 5/8" per side)*

## LAYING PATTERNS

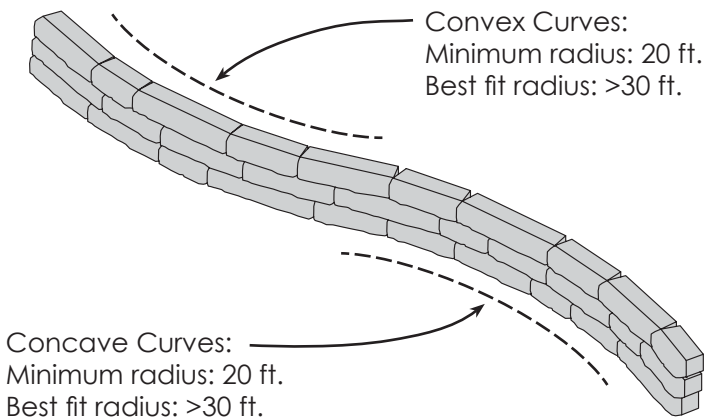

Convex Curves:  
Minimum radius: 20 ft.  
Best fit radius: >30 ft.

Concave Curves:  
Minimum radius: 20 ft.  
Best fit radius: >30 ft.

Note: Minimum radii shown are based on an average mix of block lengths. Actual radius will depend upon block placement.

Due to the setback between courses of blocks (2.25 inches per course), the radius of convex curves will get smaller towards the top of the wall. It is recommended that you plan your base course layout accordingly due to the tapered ends of the upper courses becoming tighter. The overall radius will decrease as the wall is constructed.

## NOTES



WET-CAST  
WARRANTY



DO NOT USE  
DE-ICING AGENTS



GRAND LEDGE  
COPING/FREESTANDING



OUTDOOR  
LIVING



WALLS &  
COLUMNS

## CAP OPTIONS

## APPLICATIONS

COLOR SWATCHES AVAILABLE AT LAMPUS.COM • ALL WEIGHTS ARE APPROXIMATE

# ROSETTA® GRAND LEDGE CORNERS

## PALLET OVERVIEW

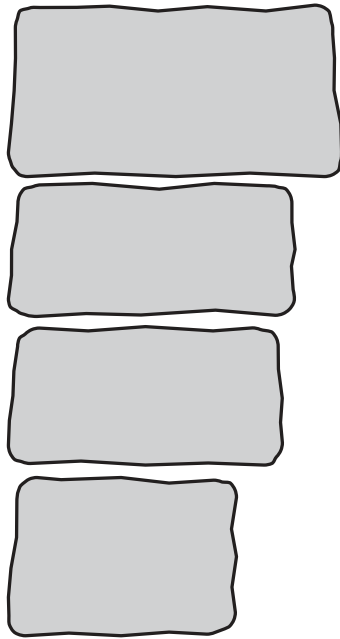

4 units / pallet  
 21 sq. ft. / pallet  
 3,950 lbs. / pallet  
 4 unique textures

## SPECIFICATIONS



51" x 26" x 12"  
 1,280 lbs. / unit  
 1 unit / pallet



46" x 21" x 12"  
 970 lbs. / unit  
 1 unit / pallet



43" x 20" x 12"  
 840 lbs. / unit  
 1 unit / pallet



35" x 24" x 12"  
 850 lbs. / unit  
 1 unit / pallet

These Corner blocks are designed for use as corners, top blocks, and step returns.

## LAYING PATTERNS

### 90° OUTSIDE CORNER

- 1 - 51" x 26" x 12"
- 2 - 35" x 24" x 12"
- 3 - 46" x 21" x 12"
- 4 - 43" x 20" x 12"

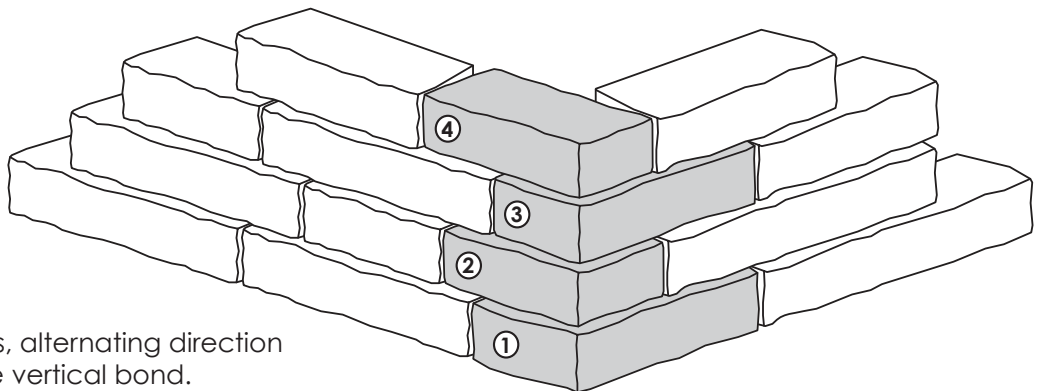

Overlap Corner blocks, alternating direction each row to break the vertical bond.

## NOTES



WET-CAST  
 WARRANTY



DO NOT USE  
 DE-ICING AGENTS



GRAND LEDGE  
 COPING/FREESTANDING



OUTDOOR  
 LIVING



WALLS &  
 COLUMNS

## CAP OPTIONS

## APPLICATIONS

COLOR SWATCHES AVAILABLE AT LAMPUS.COM • ALL WEIGHTS ARE APPROXIMATE



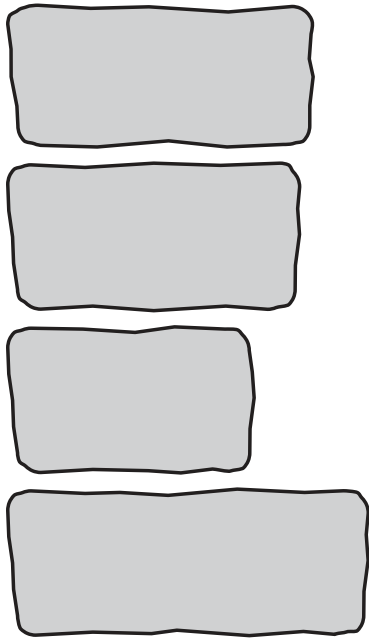

# ROSETTA® GRAND LEDGE COPING/FREESTANDING

## PALLET OVERVIEW



4 units / pallet  
 15 sq. ft. / pallet  
 3,590 lbs. / pallet  
 4 unique textures

## SPECIFICATIONS

	46" x 21" x 12" 970 lbs. / unit 1 unit / pallet
	43" x 20" x 12" 840 lbs. / unit 1 unit / pallet
	36" x 20" x 12" 700 lbs. / unit 1 unit / pallet
	54" x 20" x 12" 1,080 lbs. / unit 1 unit / pallet

## LAYING PATTERNS

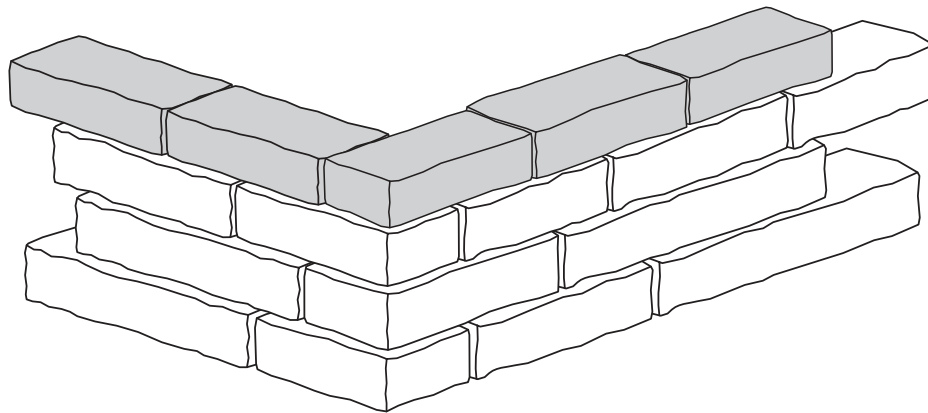

Note: The Grand Ledge Coping/Freestanding units have a natural stone finish on 5 sides and can be used for corners, top blocks, step returns, and freestanding walls.

## NOTES



WET-CAST  
WARRANTY



DO NOT USE  
DE-ICING AGENTS

COLOR SWATCHES AVAILABLE AT LAMPUS.COM • ALL WEIGHTS ARE APPROXIMATE

## APPLICATIONS



OUTDOOR  
LIVING



WALLS &  
COLUMNS

# ROSETTA® KODAH

## PALLET OVERVIEW

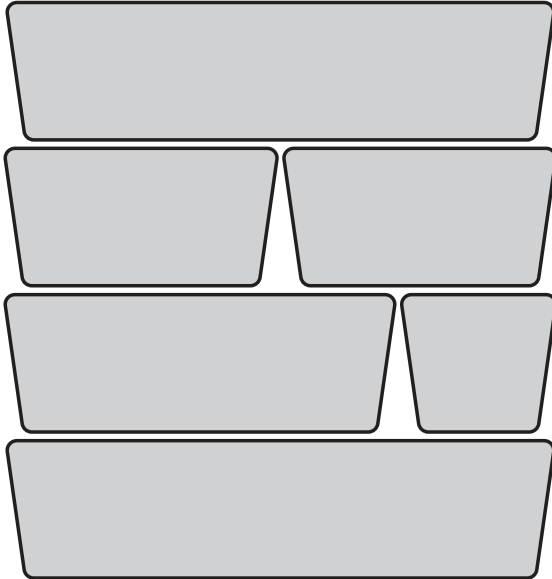

18 units / pallet  
 Retaining Wall: 21 sq. ft. / pallet  
 Seating Wall: 20 sq. ft. / pallet  
 3 layers / pallet  
 2,400 lbs. / pallet  
 8 1/2' minimum radius

## SPECIFICATIONS



42" x 10 1/2" x 6"  
 200 lbs. / unit  
 6 units / pallet



30" x 10 1/2" x 6"  
 140 lbs. / unit  
 3 units / pallet



21" x 10 1/2" x 6"  
 100 lbs. / unit  
 6 units / pallet



12" x 10 1/2" x 6"  
 50 lbs. / unit  
 3 units / pallet

*Recommended Setback/Batter = 3/4" per 6"  
 Wall blocks have a 3" taper (1 1/2" per side).*

## LAYING PATTERNS



• This random laying pattern uses one full pallet of block.

## NOTES



WET-CAST  
 WARRANTY



DO NOT USE  
 DE-ICING AGENTS



DIMENSIONAL  
 COPING

## APPLICATIONS



OUTDOOR  
 LIVING



WALLS &  
 COLUMNS

COLOR SWATCHES AVAILABLE AT LAMPUS.COM • ALL WEIGHTS ARE APPROXIMATE

# ROSETTA® KODAH CORNER

## PALLET OVERVIEW

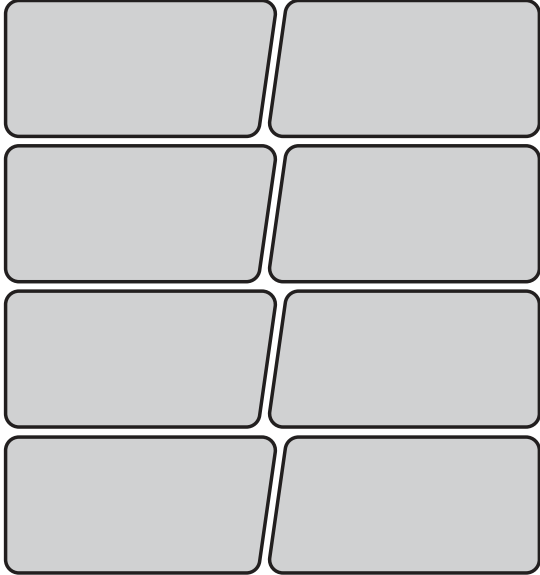

24 units / pallet  
31.5 sq. ft. / pallet  
3 layers / pallet  
2,500 lbs. / pallet

## SPECIFICATIONS



21" x 10 1/2" x 6"  
100 lbs. / unit  
1.3 sq. ft / unit

## LAYING PATTERNS

• One pallet of corner blocks will make a 32" x 32" x 36" high column.

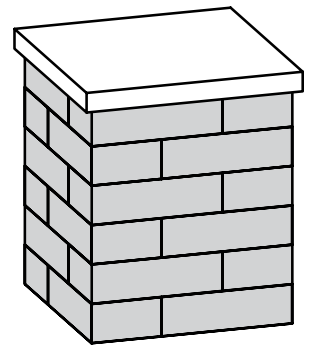
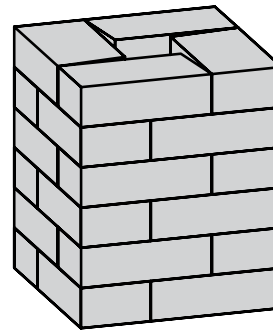
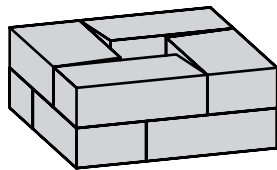
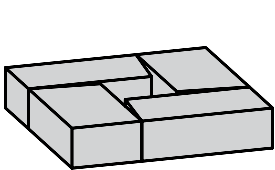

## NOTES



WET-CAST  
WARRANTY



DO NOT USE  
DE-ICING AGENTS

COLOR SWATCHES AVAILABLE AT [LAMPUS.COM](http://LAMPUS.COM) • ALL WEIGHTS ARE APPROXIMATE

## APPLICATIONS



OUTDOOR  
LIVING



WALLS &  
COLUMNS



# ROSETTA® OUTCROPPING CORNER

## PALLET OVERVIEW

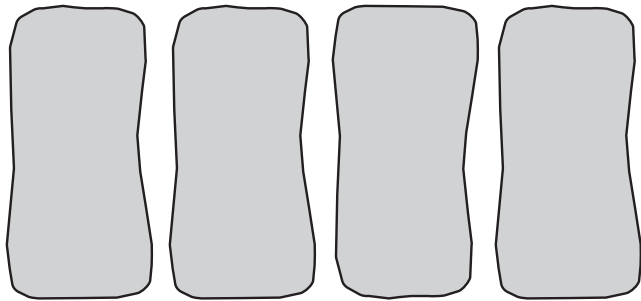
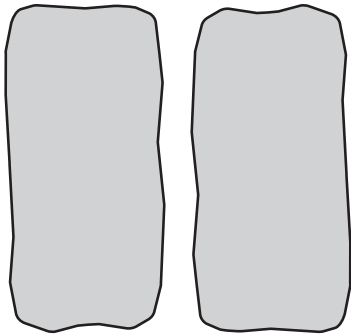

## SPECIFICATIONS



12" CORNER PALLET  
48" x 30" x 12"  
2 unit / pallet  
2 layers / pallet  
2,200 lbs. / pallet



6" CORNER PALLET  
39" x 27" x 6"  
4 unit / pallet  
2 layers / pallet  
2,200 lbs. / pallet

## LAYING PATTERNS

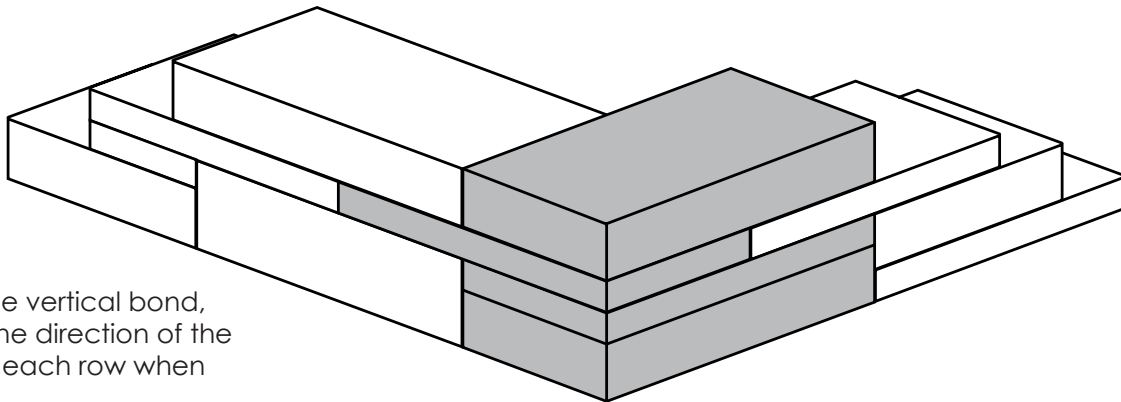

To break the vertical bond, alternate the direction of the corners on each row when possible.

## NOTES



WET-CAST  
WARRANTY



DO NOT USE  
DE-ICING AGENTS

## CAP OPTIONS



IRREGULAR  
STEPS

## APPLICATIONS



WALLS &  
COLUMNS

COLOR SWATCHES AVAILABLE AT [LAMPUS.COM](http://LAMPUS.COM) • ALL WEIGHTS ARE APPROXIMATE

# VERSA-LOK® STANDARD

## PALLET OVERVIEW

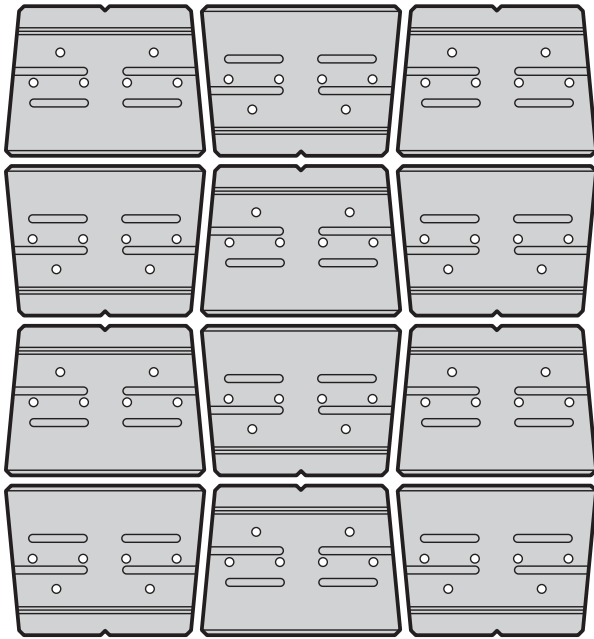

24 units / pallet  
 16 sq. ft. / pallet  
 2 layers / pallet  
 2,100 lbs. / pallet

## SPECIFICATIONS



16" x 12" x 6"  
 86 lbs. / unit  
 1.5 units / sq. ft.



*Weathered unit is palletized the same.*



*Solid unit is palletized the same.*

8" minimum radius  
 Setback/Batter =  $\frac{3}{4}$ " per 6"  
 Blocks have a 2" taper (1" per side)

## LAYING PATTERNS

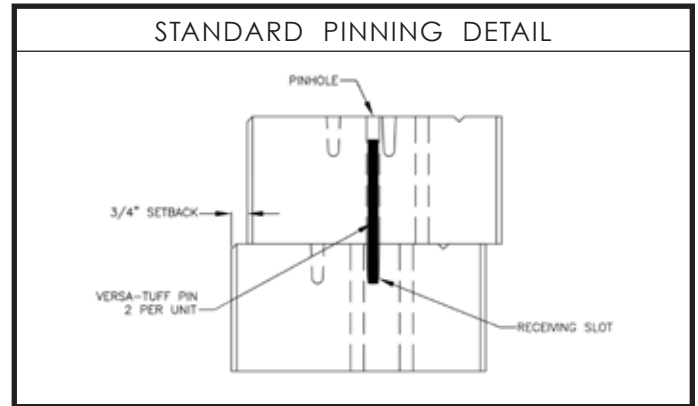
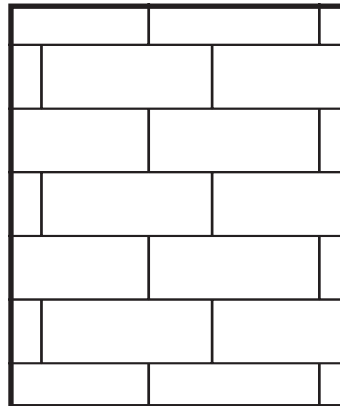
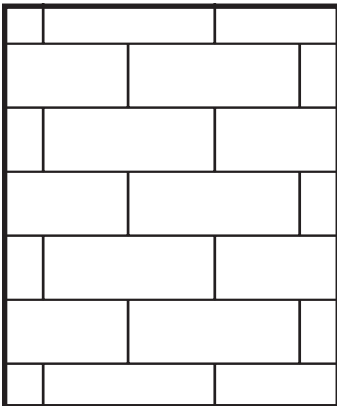

## NOTES



DRY-CAST  
 WARRANTY

## CAP OPTIONS



C CAPS



C-2 CAPS



DOUBLE  
 BULLNOSE CAPS



DIMENSIONAL  
 COPING



LIMESTONE  
 COLUMN CAPS

## APPLICATIONS



OUTDOOR  
 LIVING



WALLS &  
 COLUMNS

COLOR SWATCHES AVAILABLE AT LAMPUS.COM • ALL WEIGHTS ARE APPROXIMATE

# VERSA-LOK® STANDARD

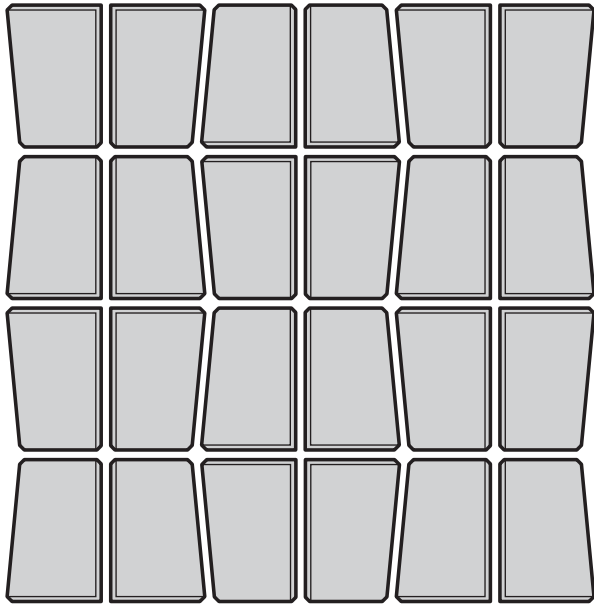

48 units / pallet  
2 layers / pallet  
2,100 lbs. / pallet



HALF CORNER  
8" x 12" x 6"  
44 lbs. / unit

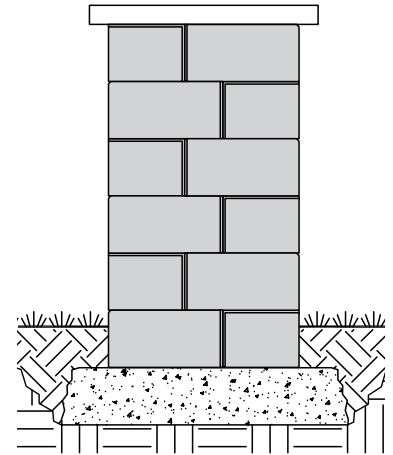
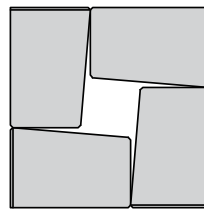
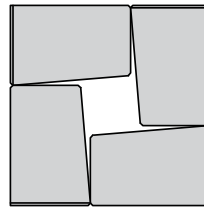

One pallet of half blocks will make  
two 20" x 20" x 36" columns.

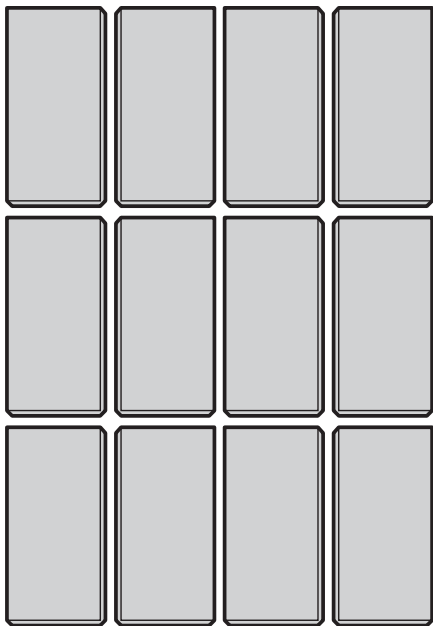

36 units / pallet  
3 layers / pallet  
2,280 lbs. / pallet



FULL RETURN CORNER  
16" x 8" x 6"  
63 lbs. / unit

*\*See above for column detail.*

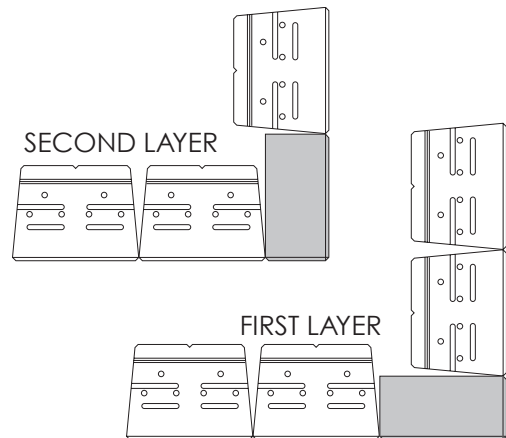

To stay on half bond when installing a 90° outside corner, alternate the direction of the full return corner block on each row. Place masonry adhesive between corner blocks for additional strength.

COLOR SWATCHES AVAILABLE AT [LAMPUS.COM](http://LAMPUS.COM) • ALL WEIGHTS ARE APPROXIMATE

# VERSA-LOK® CLEAN CUT

## PALLET OVERVIEW

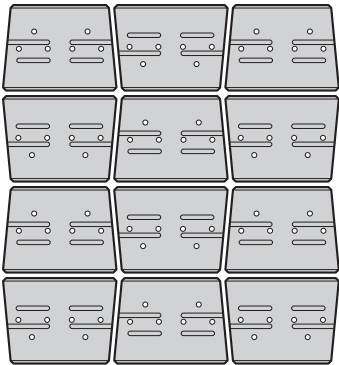

CLEAN CUT  
36 units / pallet  
24 sq. ft. / pallet  
3 layers / pallet  
2,916 lbs. / pallet

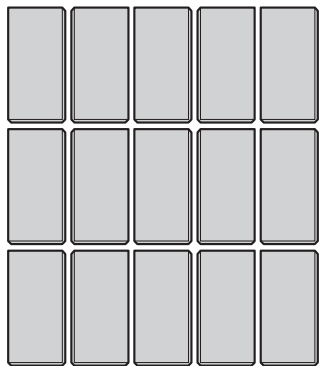

CLEAN CUT  
FULL RETURN CORNER  
45 units / pallet  
3 layers / pallet  
2,500 lbs. / pallet

## SPECIFICATIONS



CLEAN CUT  
16" x 12" x 6"  
86 lbs. / unit  
1.5 units / sq. ft.

8' minimum radius  
Setback/Batter =  $\frac{3}{4}$ " per 6"  
Blocks have a 2" taper (1" per side).  
Clean Cut blocks are double sided.



CLEAN CUT  
FULL RETURN CORNER  
16" x 8" x 6"  
86 lbs. / unit

## LAYING PATTERNS

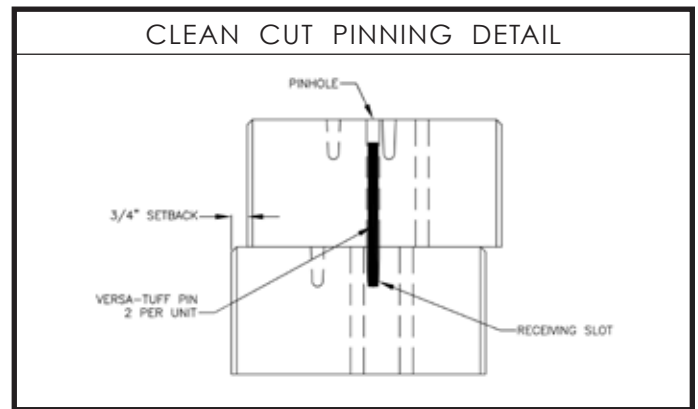
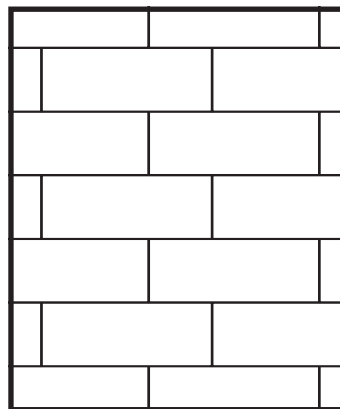
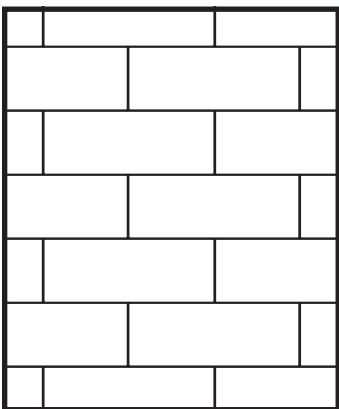

## NOTES

## CAP OPTIONS

## APPLICATIONS



CLEAN CUT CAPS



C CAPS



C-2 CAPS



DOUBLE BULLNOSE CAPS



LIMESTONE COLUMN CAPS



OUTDOOR LIVING



WALLS & COLUMNS

COLOR SWATCHES AVAILABLE AT LAMPUS.COM • ALL WEIGHTS ARE APPROXIMATE

# VERSA-LOK® COBBLE

## PALLET OVERVIEW

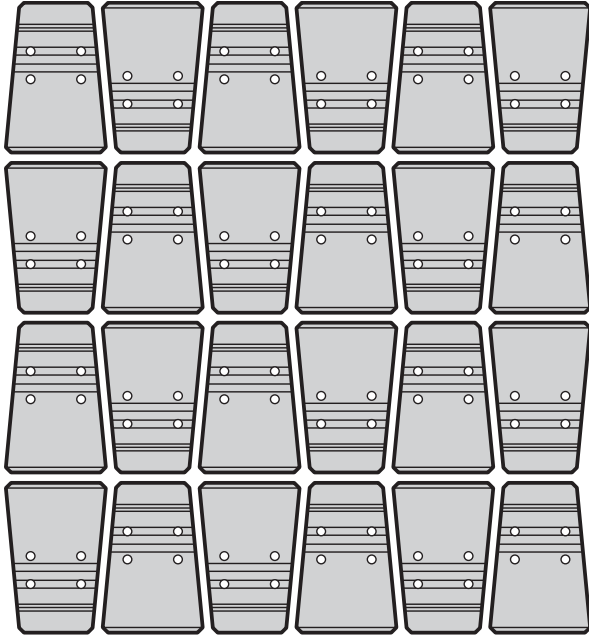

48 units / pallet  
 16 sq. ft. / pallet  
 2 layers / pallet  
 1,872 lbs. / pallet

## SPECIFICATIONS



8" x 12" x 6"  
 38 lbs. / unit  
 3 units / sq. ft.



*Weathered unit is palletized the same.*

4.3' minimum radius  
 Setback/Batter =  $\frac{3}{4}$ " per 6"  
 Blocks have a 2" taper (1" per side).

## LAYING PATTERNS

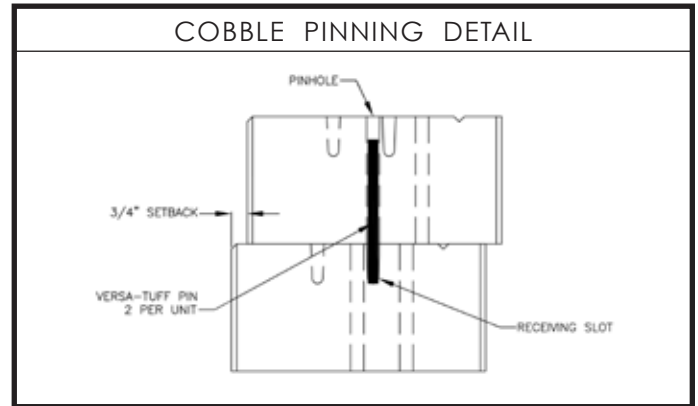
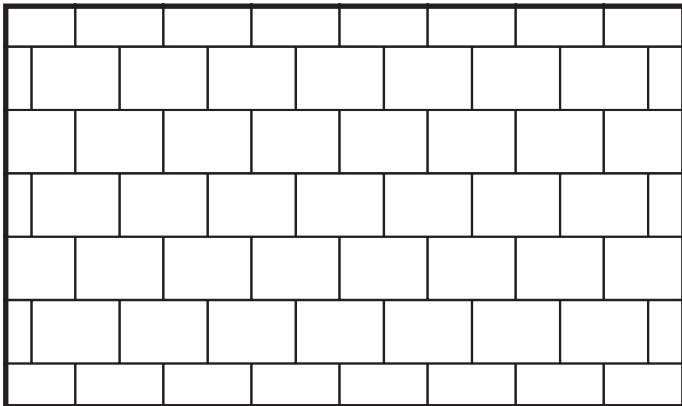

## NOTES



DRY-CAST  
 WARRANTY

## CAP OPTIONS



C CAPS



C-2 CAPS



DOUBLE  
 BULLNOSE CAPS



DIMENSIONAL  
 COPING



LIMESTONE  
 COLUMN CAPS

## APPLICATIONS



OUTDOOR  
 LIVING



WALLS &  
 COLUMNS

COLOR SWATCHES AVAILABLE AT LAMPUS.COM • ALL WEIGHTS ARE APPROXIMATE

# VERSA-LOK® HARMONY

## PALLET OVERVIEW

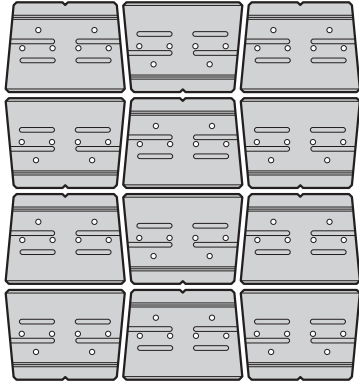

**STANDARD**  
24 units / pallet  
16 sq. ft. / pallet  
2 layers / pallet  
2,100 lbs. / pallet

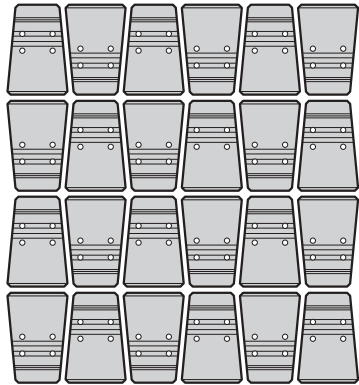

**COBBLE**  
48 units / pallet  
16 sq. ft. / pallet  
2 layers / pallet  
1,872 lbs. / pallet

## SPECIFICATIONS



**STANDARD**  
16" x 12" x 6"  
86 lbs. / unit  
1.5 units / sq. ft.



**COBBLE**  
8" x 12" x 6"  
38 lbs. / unit  
3 units / sq. ft.

<b>HARMONY INSTALLATION RATIOS</b>	<p><b>1:1 RATIO: 1 Standard (66%) : 1 Cobble (33%)</b> Total square feet of the wall is equal to how many of each unit you will need. • <b>Example:</b> 100 Sq. Ft. Wall 100 Standard Units 100 Cobble Units</p>
	<p><b>1:2 RATIO: 1 Standard (50%) : 2 Cobble (50%)</b> Total square feet of the wall is divided in half. Multiply that number by 1.5 for Standards and 3 for Cobbles. • <b>Example:</b> 100 Sq. Ft. Wall: <math>100 \div 2 = 50</math> <math>50 \times 1.5 = 75</math> Standard Units <math>50 \times 3 = 150</math> Cobble Units</p>
	<p><b>3:2 RATIO: 3 Standard (75%) : 2 Cobble (25%)</b> Total square feet of the wall is divided by 2.66. Multiply that number by 3 for Standards and 2 for Cobbles. • <b>Example:</b> 100 Sq. Ft. Wall: <math>100 \div 2.66 = 37.6</math> (38) <math>38 \times 3 = 114</math> Standard Units <math>38 \times 2 = 76</math> Cobble Units</p>

## LAYING PATTERNS

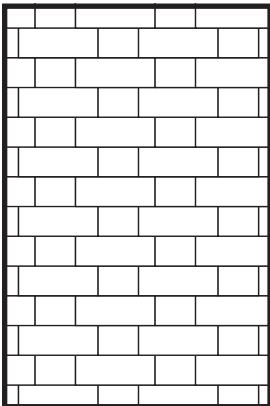

1:1 RATIO

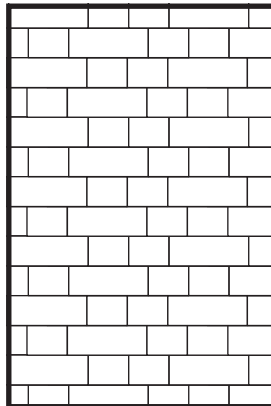

1:2 RATIO

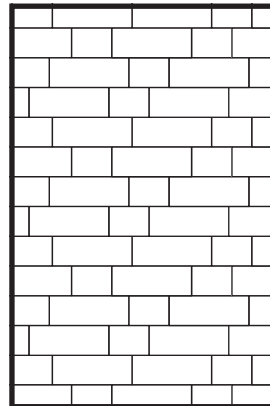

3:2 RATIO

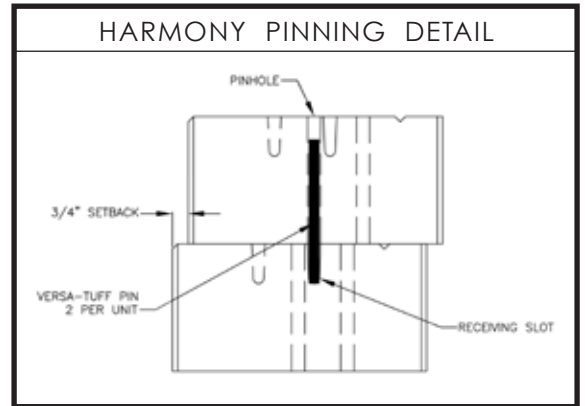

## NOTES



DRY-CAST WARRANTY

## CAP OPTIONS



C CAPS



C-2 CAPS



DOUBLE BULLNOSE CAPS



DIMENSIONAL COPING



LIMESTONE COLUMN CAPS

## APPLICATIONS



OUTDOOR LIVING



WALLS & COLUMNS

COLOR SWATCHES AVAILABLE AT LAMPUS.COM • ALL WEIGHTS ARE APPROXIMATE

# VERSA-LOK® SQ. FT. BLOCK

## PALLET OVERVIEW

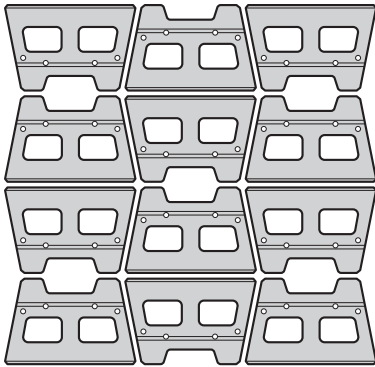

24 units / pallet  
 24 sq. ft. / pallet  
 2 layers / pallet  
 2,256 lbs. / pallet

## SPECIFICATIONS



18" x 12" x 8"  
 94 lbs. / unit  
 1 unit / sq. ft.

4.5' minimum radius  
 Setback/Batter = 1" per 8"  
 Blocks have a 4" taper (2" per side).

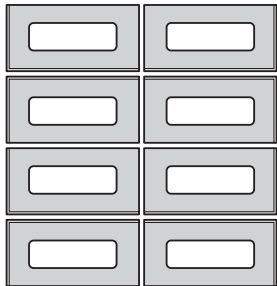

SQ. FT. FULL RETURN  
 CORNER  
 24 units / pallet  
 3 layers / pallet  
 1,800 lbs. / pallet

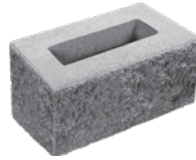

SQ. FT. FULL RETURN  
 CORNER  
 18" x 9" x 8"  
 75 lbs. / unit

## LAYING PATTERNS

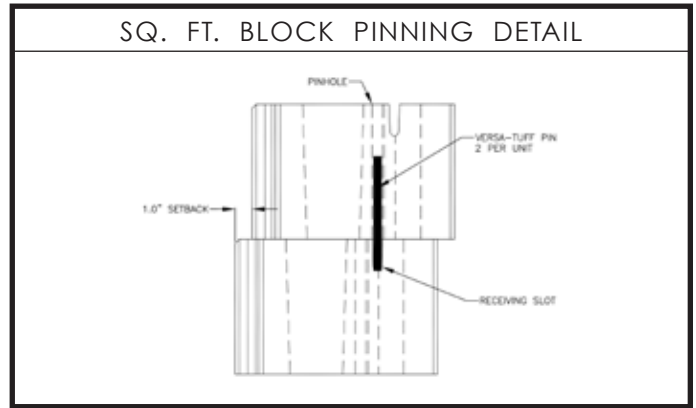
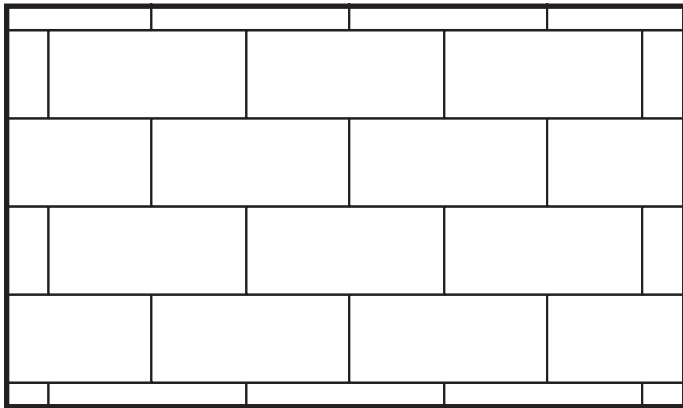

## NOTES



DRY-CAST  
 WARRANTY

## CAP OPTIONS



C CAPS



C-2 CAPS



DOUBLE  
 BULLNOSE CAPS



DIMENSIONAL  
 COPING

## APPLICATIONS



WALLS &  
 COLUMNS

COLOR SWATCHES AVAILABLE AT LAMPUS.COM • ALL WEIGHTS ARE APPROXIMATE

# MAGNUMSTONE®

## STANDARD BLOCKS



### STANDARD

48" x 25" x 24"  
1,270 lbs. / unit  
2 units / pallet  
8 sq. ft. / unit  
9" Taper (4.5" per side)  
Volume Voids: 6.1 cu. ft.  
Setback/Batter: 1" (2.4°)

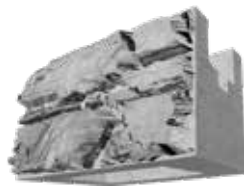

### STANDARD BASE

48" x 25" x 24"  
1,295 lbs. / unit  
2 units / pallet  
8 sq. ft. / unit  
9" Taper (4.5" per side)  
Volume Voids: 6.1 cu. ft.  
Setback/Batter: 1" (2.4°)



### STANDARD TOP

48" x 25" x 24"  
1,220 lbs. / unit  
2 units / pallet  
8 sq. ft. / unit  
9" Taper (4.5" per side)  
Volume Voids: 6.1 cu. ft.  
Setback/Batter: 1" (2.4°)

## EXTENDERS



### 4 FT. EXTENDER

24" x 48" x 30"  
800 lbs. / unit  
2 units / pallet



### 2 FT. EXTENDER

24" x 24" x 30"  
573 lbs. / unit  
2 units / pallet

## HALF-WIDE BLOCKS



### HALF-WIDE

24" x 25" x 24"  
730 lbs. / unit  
4 units / pallet  
4 sq. ft. / unit  
9.5" Taper (4.75" per side)  
No Voids: Solid Unit  
Setback/Batter: 1" (2.4°)



### HALF-WIDE BASE

24" x 25" x 24"  
710 lbs. / unit  
4 units / pallet  
4 sq. ft. / unit  
9.5" Taper (4.75" per side)  
No Voids: Solid Unit  
Setback/Batter: 1" (2.4°)



### HALF-WIDE TOP

24" x 25" x 24"  
680 lbs. / unit  
4 units / pallet  
4 sq. ft. / unit  
9.5" Taper (4.75" per side)  
No Voids: Solid Unit  
Setback/Batter: 1" (2.4°)

## STEP/CAP



### STEP/CAP

6" x 24" x 48"  
580 lbs. / unit  
6 units / pallet  
4 in. ft. / unit

## CORNER BLOCKS



### FULL RETURN CORNER\*

47" x 23" x 24"  
1,700 lbs. / unit  
2 units / pallet  
11.67 sq. ft. / unit  
4.01 cu. ft. - volume voids  
1" (2.4°) - setback/batter  
Left & Right units available



### FULL RETURN CORNER BASE\*

47" x 23" x 24"  
1,700 lbs. / unit  
2 units / pallet  
11.67 sq. ft. / unit  
4.01 cu. ft. - volume voids  
1" (2.4°) - setback/batter  
Left & Right units available



### FULL RETURN CORNER TOP\*

47" x 23" x 24"  
1,600 lbs. / unit  
2 units / pallet  
11.67 sq. ft. / unit  
4.01 cu. ft. - volume voids  
1" (2.4°) - setback/batter  
Left & Right units available



### UNIVERSAL END/CORNER

4"~9" x 28" x 24"  
270 lbs. / unit  
2 units / pallet  
4.66 sq. ft. / unit

\*Full Return Corner, FRC Base, & FRC Top have a Left & Right option. Select Left & Right units looking at the face of the wall design.

# MAGNUMSTONE®

## HALF-HIGH BLOCKS

## CORNERS



### HALF-HIGH

48" x 25" x 12"  
645 lbs. / unit  
2 units / pallet  
4 sq. ft. / unit  
9" Taper (4.5" per side)  
Volume Voids: 3.15 cu. ft.  
Setback/Batter: 1" (2.4°)



### HALF-HIGH BASE

48" x 25" x 12"  
635 lbs. / unit  
2 units / pallet  
4 sq. ft. / unit  
9" Taper (4.5" per side)  
Volume Voids: 3.15 cu. ft.  
Setback/Batter: 1" (2.4°)



### HALF-HIGH TOP

48" x 25" x 12"  
590 lbs. / unit  
2 units / pallet  
4 sq. ft. / unit  
9" Taper (4.5" per side)  
Volume Voids: 3.15 cu. ft.  
Setback/Batter: 1" (2.4°)



### HALF-HIGH END/CORNER\*

4"~9" x 28" x 12"  
128 lbs. / unit  
4 units / pallet  
2.33 sq. ft.  
Left & Right units available  
\*Select Left & Right units looking at the face of the wall design.

## HALF-HIGH FREESTANDING BLOCKS



### HALF-HIGH 2-SIDED FREESTANDING

48" x 26" x 12"  
525 lbs. / unit  
2 units / pallet  
4 sq. ft. / unit



### HALF-HIGH 2-SIDED FREESTANDING BASE

48" x 26" x 12"  
525 lbs. / unit  
2 units / pallet  
4 sq. ft. / unit



### HALF-HIGH 3-SIDED FREESTANDING END

48" x 26" x 12"  
575 lbs. / unit  
2 units / pallet  
4 sq. ft. / unit



### HALF-HIGH 3-SIDED FREESTANDING END BASE

48" x 26" x 12"  
575 lbs. / unit  
2 units / pallet  
4 sq. ft. / unit

## MAGNUMSTONE TYPICAL CROSS SECTIONS

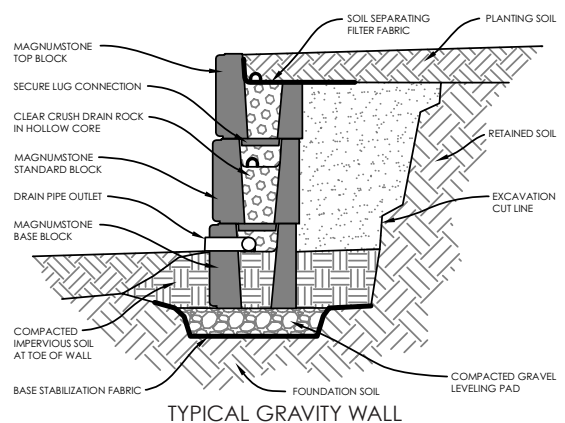
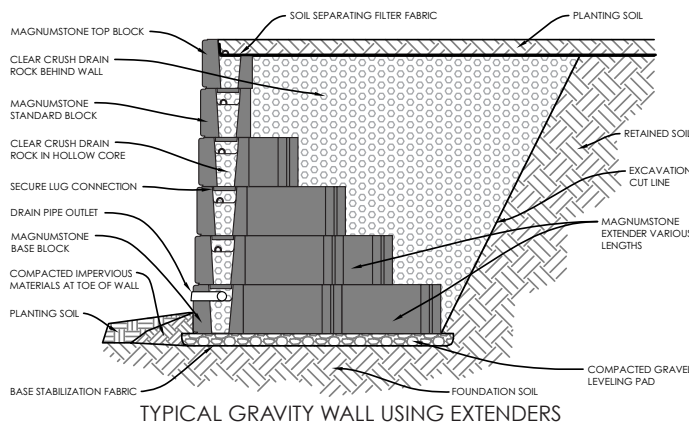

## NOTES

## CAP OPTIONS

## APPLICATIONS



WET-CAST WARRANTY



DO NOT USE DE-ICING AGENTS



MAGNUMSTONE® STEP/CAP



WALLS & COLUMNS

COLOR SWATCHES AVAILABLE AT LAMPUS.COM • ALL WEIGHTS ARE APPROXIMATE