

ROSETTA® GRAND LEDGE

PALLET OVERVIEW

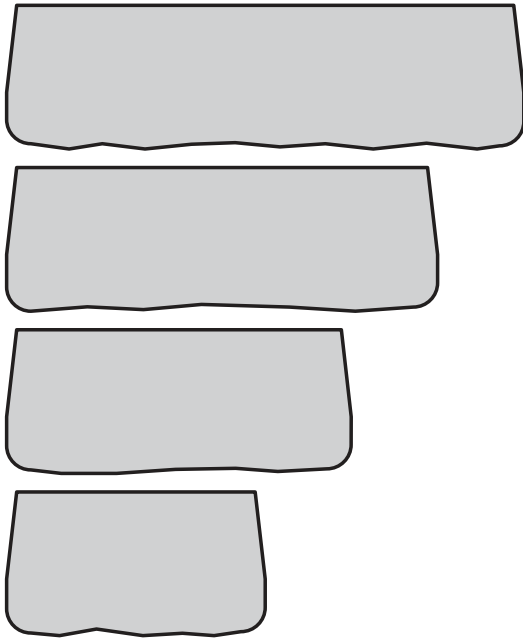

4 units / pallet
18 sq. ft. / pallet
4,000 lbs. / pallet
24 unique textures

SPECIFICATIONS



72" x 20" x 12"
1,350 lbs. / unit
1 unit / pallet



60" x 20" x 12"
1,080 lbs. / unit
1 unit / pallet



48" x 20" x 12"
890 lbs. / unit
1 unit / pallet



36" x 20" x 12"
660 lbs. / unit
1 unit / pallet

*Setback/Batter = 2 1/4" per 12"
Wall blocks have a 3 1/4" taper (1 5/8" per side)*

LAYING PATTERNS

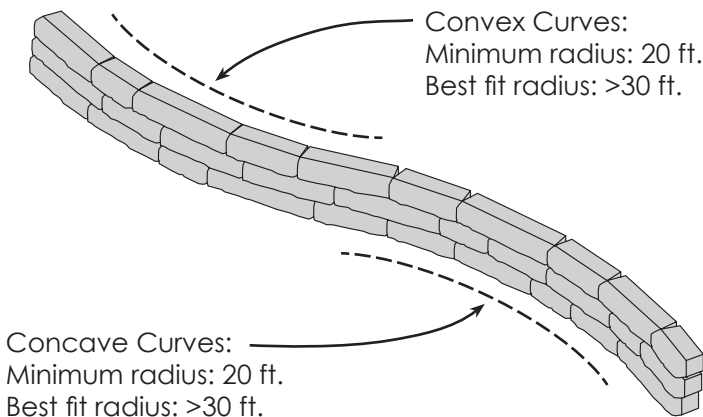

Note: Minimum radii shown are based on an average mix of block lengths. Actual radius will depend upon block placement.

Due to the setback between courses of blocks (2.25 inches per course), the radius of convex curves will get smaller towards the top of the wall. It is recommended that you plan your base course layout accordingly due to the tapered ends of the upper courses becoming tighter. The overall radius will decrease as the wall is constructed.

NOTES



WET-CAST
WARRANTY



DO NOT USE
DE-ICING AGENTS



GRAND LEDGE
COPING/FREESTANDING



OUTDOOR
LIVING



WALLS &
COLUMNS

APPLICATIONS

COLOR SWATCHES AVAILABLE AT LAMPUS.COM • ALL WEIGHTS ARE APPROXIMATE

ROSETTA® GRAND LEDGE CORNERS

PALLET OVERVIEW

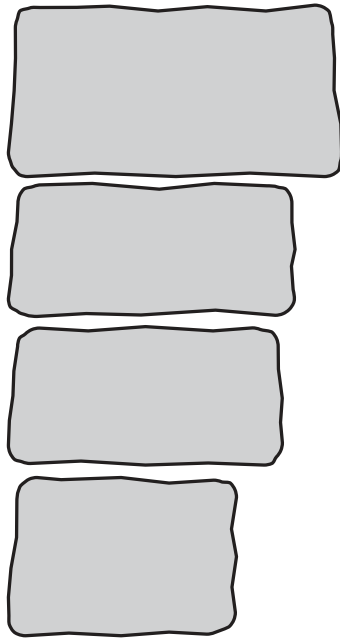

4 units / pallet
 21 sq. ft. / pallet
 3,950 lbs. / pallet
 4 unique textures

SPECIFICATIONS



51" x 26" x 12"
 1,280 lbs. / unit
 1 unit / pallet



46" x 21" x 12"
 970 lbs. / unit
 1 unit / pallet



43" x 20" x 12"
 840 lbs. / unit
 1 unit / pallet



35" x 24" x 12"
 850 lbs. / unit
 1 unit / pallet

These Corner blocks are designed for use as corners, top blocks, and step returns.

LAYING PATTERNS

90° OUTSIDE CORNER

- 1 - 51" x 26" x 12"
- 2 - 35" x 24" x 12"
- 3 - 46" x 21" x 12"
- 4 - 43" x 20" x 12"

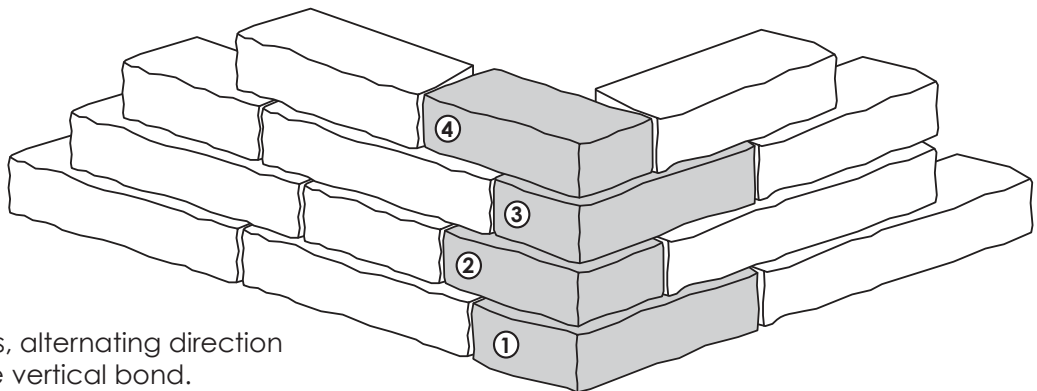

Overlap Corner blocks, alternating direction each row to break the vertical bond.

NOTES



WET-CAST
 WARRANTY



DO NOT USE
 DE-ICING AGENTS



GRAND LEDGE
 COPING/FREESTANDING



OUTDOOR
 LIVING



WALLS &
 COLUMNS

CAP OPTIONS

APPLICATIONS

COLOR SWATCHES AVAILABLE AT LAMPUS.COM • ALL WEIGHTS ARE APPROXIMATE



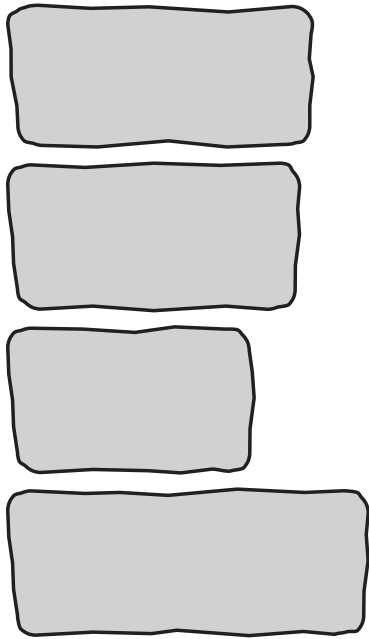

ROSETTA® GRAND LEDGE COPING/FREESTANDING

PALLET OVERVIEW



4 units / pallet
 15 sq. ft. / pallet
 3,590 lbs. / pallet
 4 unique textures

SPECIFICATIONS

	46" x 21" x 12" 970 lbs. / unit 1 unit / pallet
	43" x 20" x 12" 840 lbs. / unit 1 unit / pallet
	36" x 20" x 12" 700 lbs. / unit 1 unit / pallet
	54" x 20" x 12" 1,080 lbs. / unit 1 unit / pallet

LAYING PATTERNS

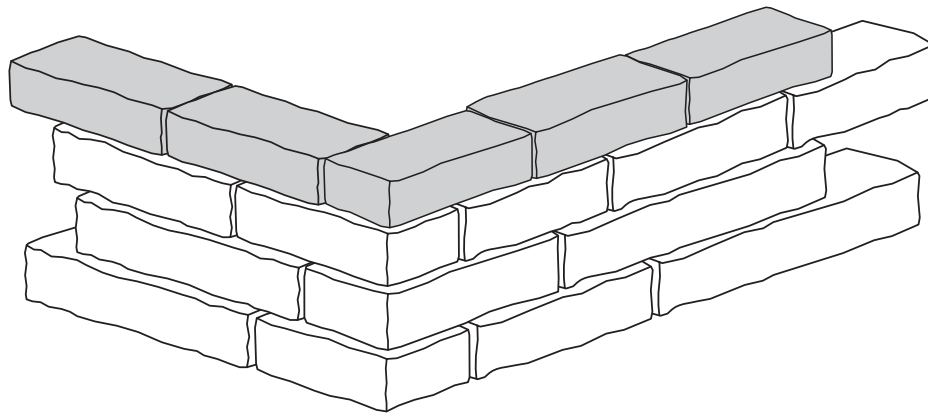

Note: The Grand Ledge Coping/Freestanding units have a natural stone finish on 5 sides and can be used for corners, top blocks, step returns, and freestanding walls.

NOTES



WET-CAST
WARRANTY



DO NOT USE
DE-ICING AGENTS

COLOR SWATCHES AVAILABLE AT LAMPUS.COM • ALL WEIGHTS ARE APPROXIMATE

APPLICATIONS



OUTDOOR
LIVING



WALLS &
COLUMNS