

# ROSETTA® OUTCROPPING

## SPECIFICATIONS

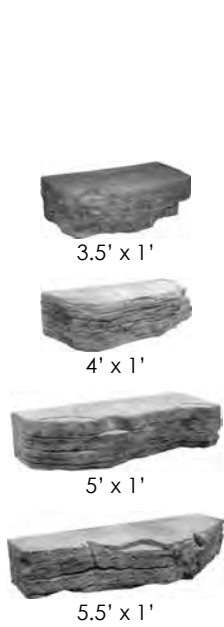

**A PALLET:**  
 4 units / pallet  
 18 face sq. ft. / pallet  
 220 lbs. / sq. ft.  
 4,000 lbs. / pallet



**B PALLET:**  
 6 units / pallet  
 18 face sq. ft. / pallet  
 220 lbs. / sq. ft.  
 4,000 lbs. / pallet



**C PALLET:**  
 4 units / pallet  
 18 face sq. ft. / pallet  
 220 lbs. / sq. ft.  
 4,000 lbs. / pallet

## LAYING PATTERNS

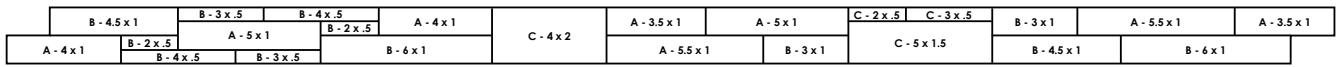

2' x 45' WALL - 90 sq. ft. (Uses 2 A Pallets, 2 B Pallets, & 1 C Pallet)

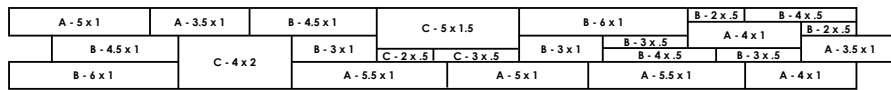

3' x 30' WALL - 90 sq. ft. (Uses 2 A Pallets, 2 B Pallets, & 1 C Pallet)

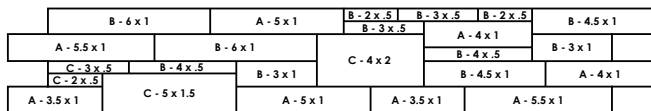

4' x 22 1/2' WALL - 90 sq. ft. (Uses 2 A Pallets, 2 B Pallets, & 1 C Pallet)

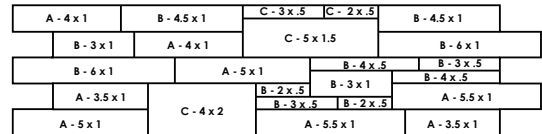

5' x 18' WALL - 90 sq. ft. (Uses 2 A Pallets, 2 B Pallets, & 1 C Pallet)

## NOTES



**WET-CAST  
 WARRANTY**

## CAP OPTIONS



**IRREGULAR  
 STEPS**

## APPLICATIONS



**WALLS &  
 COLUMNS**

COLOR SWATCHES AVAILABLE AT LAMPUS.COM • ALL WEIGHTS ARE APPROXIMATE.

# ROSETTA® OUTCROPPING CORNER

## PALLET OVERVIEW

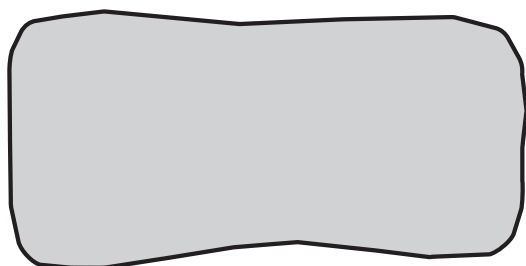
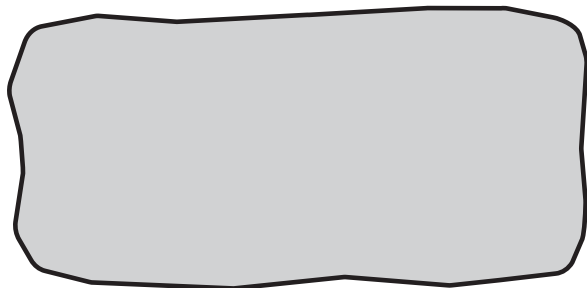

2 units / pallet  
1,650 lbs. / pallet

## SPECIFICATIONS



48" x 30" x 12"  
1 unit / pallet



39" x 27" x 6"  
1 unit / pallet

## LAYING PATTERNS

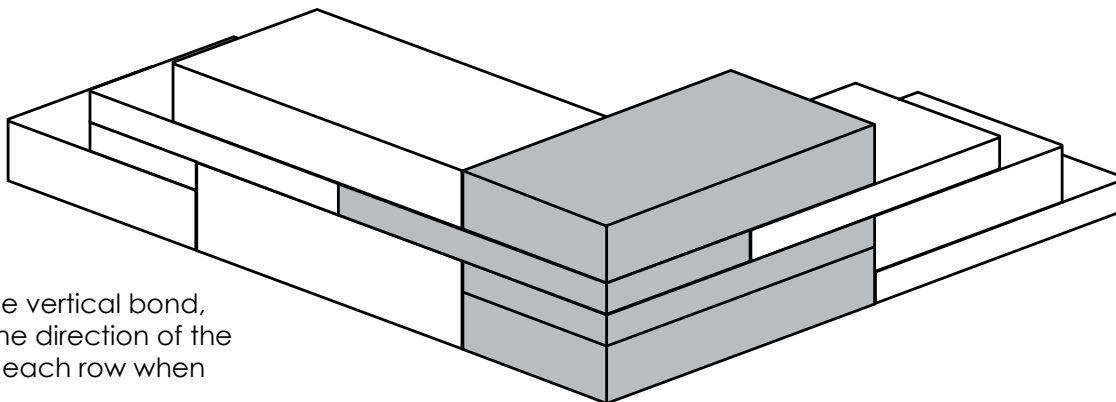

To break the vertical bond, alternate the direction of the corners on each row when possible.

## NOTES



WET-CAST  
WARRANTY

## CAP OPTIONS



IRREGULAR  
STEPS

## APPLICATIONS



WALLS &  
COLUMNS

COLOR SWATCHES AVAILABLE AT [LAMPUS.COM](http://LAMPUS.COM) • ALL WEIGHTS ARE APPROXIMATE.