

# ROSETTA® GRAND LEDGE

## PALLET OVERVIEW

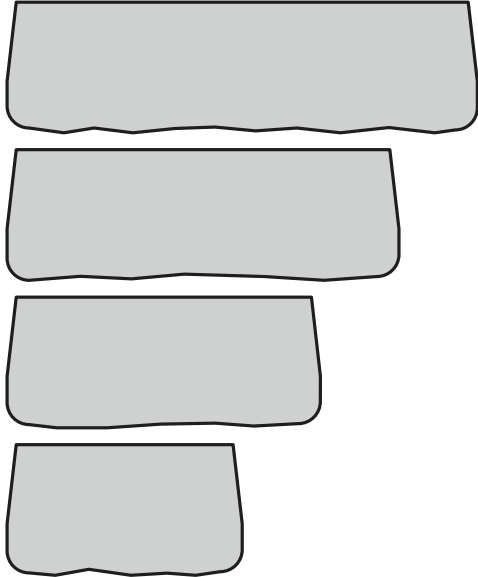

4 units / pallet  
 18 sq. ft. / pallet  
 4,000 lbs. / pallet  
 24 unique textures

## SPECIFICATIONS



72" x 20" x 12"  
 1,350 lbs. / unit  
 1 unit / pallet



60" x 20" x 12"  
 1,080 lbs. / unit  
 1 unit / pallet

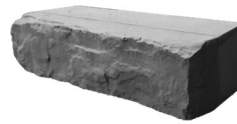

48" x 20" x 12"  
 890 lbs. / unit  
 1 unit / pallet

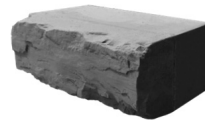

36" x 20" x 12"  
 660 lbs. / unit  
 1 unit / pallet

## LAYING PATTERNS

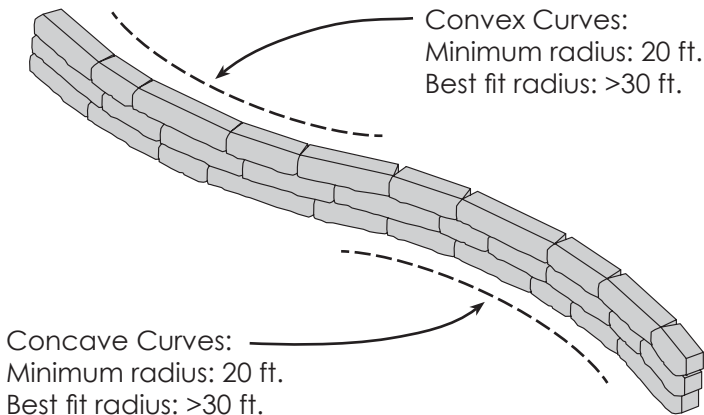

Convex Curves:  
 Minimum radius: 20 ft.  
 Best fit radius: >30 ft.

Concave Curves:  
 Minimum radius: 20 ft.  
 Best fit radius: >30 ft.

Note: Minimum radii shown are based on an average mix of block lengths. Actual radius will depend upon block placement.

Due to the setback between courses of blocks (2.25 inches per course), the radius of convex curves will get smaller towards the top of the wall. It is recommended that you plan your base course layout accordingly due to the tapered ends of the upper courses becoming tighter. The overall radius will decrease as the wall is constructed.

## NOTES



WETCAST  
 WARRANTY

## CAP OPTIONS



GRAND LEDGE  
 COPING

## APPLICATIONS



OUTDOOR  
 LIVING



WALLS &  
 COLUMNS

COLOR SWATCHES AVAILABLE AT LAMPUS.COM • ALL WEIGHTS ARE APPROXIMATE.

# ROSETTA® GRAND LEDGE 4-SIDED CORNERS

## PALLET OVERVIEW

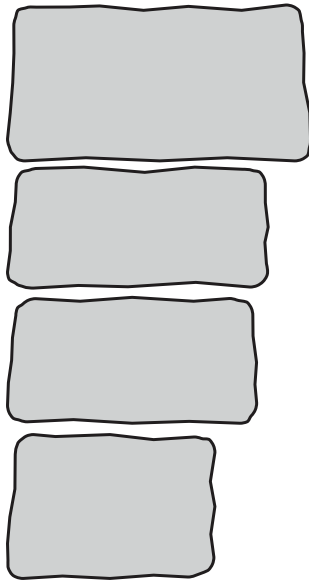

4 units / pallet  
14.5 sq. ft. / pallet  
3,950 lbs. / pallet  
4 unique textures

## SPECIFICATIONS

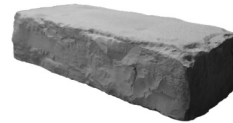

51" x 26" x 12"  
1,280 lbs. / unit  
1 unit / pallet

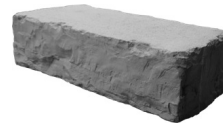

46" x 21" x 12"  
970 lbs. / unit  
1 unit / pallet



43" x 20" x 12"  
840 lbs. / unit  
1 unit / pallet

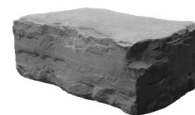

35" x 24" x 12"  
850 lbs. / unit  
1 unit / pallet

These 4-sided blocks are designed for use as corners, top blocks, and step returns.

## LAYING PATTERNS

### 90° OUTSIDE CORNER

- 1 - 51" x 26" x 12"
- 2 - 35" x 24" x 12"
- 3 - 46" x 21" x 12"
- 4 - 43" x 20" x 12"

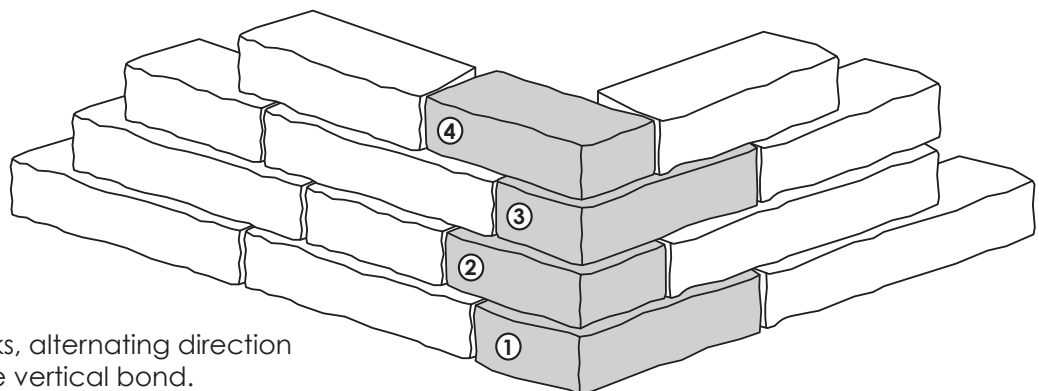

Overlap 4-Sided blocks, alternating direction each row to break the vertical bond.

## NOTES



WETCAST  
WARRANTY

## CAP OPTIONS



GRAND LEDGE  
COPING

## APPLICATIONS



OUTDOOR  
LIVING



WALLS &  
COLUMNS

COLOR SWATCHES AVAILABLE AT LAMPUS.COM • ALL WEIGHTS ARE APPROXIMATE.

# ROSETTA® GRAND LEDGE 4-SIDED COPING

## PALLET OVERVIEW

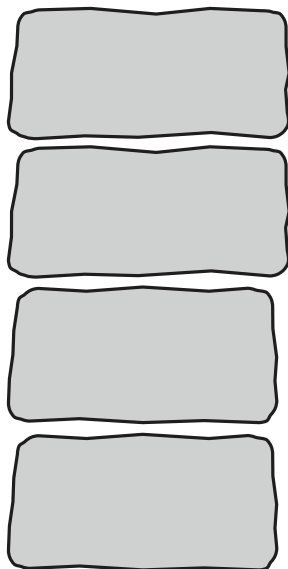

4 units / pallet  
3,620 lbs. / pallet  
2 unique textures

## SPECIFICATIONS



46" x 21" x 12"  
970 lbs. / unit  
2 units / pallet



43" x 20" x 12"  
840 lbs. / unit  
2 units / pallet

## LAYING PATTERNS

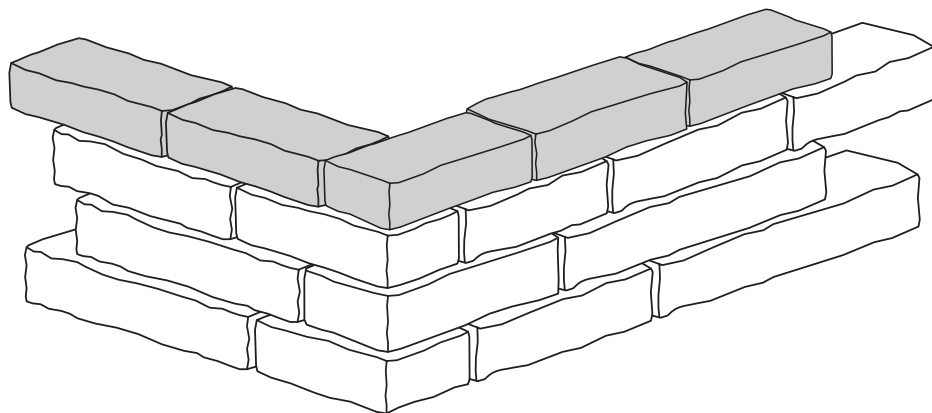

The 4-Sided Coping units give you the option to show a textured/natural finish to the top course of a Grand Ledge wall.

Note: The 4-Sided Coping units are the same size and shape as the 4-Sided Corner units, and can also be used as corners.

## NOTES



WETCAST  
WARRANTY



OUTDOOR  
LIVING



WALLS &  
COLUMNS

## APPLICATIONS

COLOR SWATCHES AVAILABLE AT LAMPUS.COM • ALL WEIGHTS ARE APPROXIMATE.