

ROSETTA® GRAND LEDGE

PALLET OVERVIEW

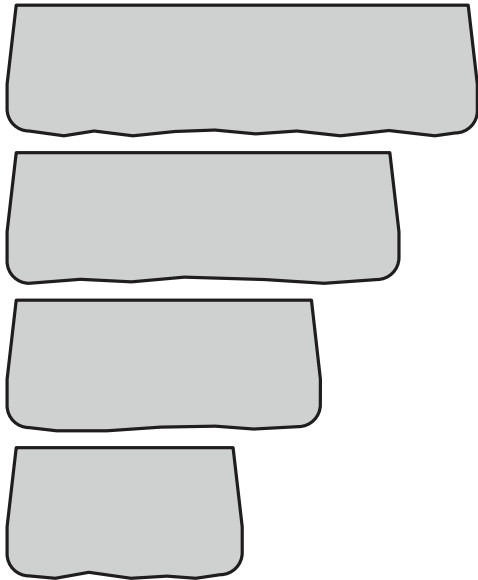

4 units / pallet
18 sq. ft. / pallet
4,000 lbs. / pallet
24 unique textures

SPECIFICATIONS



72" x 20" x 12"
1,350 lbs. / unit
1 unit / pallet



60" x 20" x 12"
1,080 lbs. / unit
1 unit / pallet

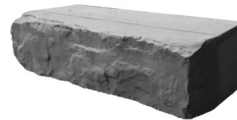

48" x 20" x 12"
890 lbs. / unit
1 unit / pallet

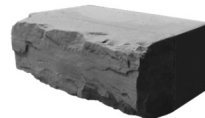

36" x 20" x 12"
660 lbs. / unit
1 unit / pallet

LAYING PATTERNS

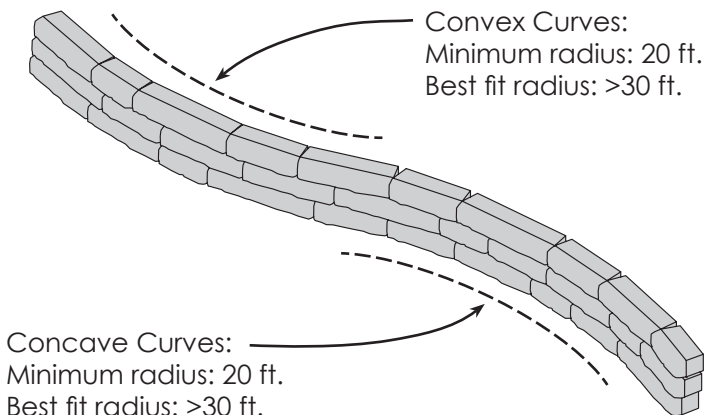

Note: Minimum radii shown are based on an average mix of block lengths. Actual radius will depend upon block placement.

Due to the setback between courses of blocks (2.25 inches per course), the radius of convex curves will get smaller towards the top of the wall. It is recommended that you plan your base course layout accordingly due to the tapered ends of the upper courses becoming tighter. The overall radius will decrease as the wall is constructed.

NOTES



WETCAST
WARRANTY



OUTDOOR
LIVING



WALLS &
COLUMNS

COLOR SWATCHES AVAILABLE AT LAMPUS.COM • ALL WEIGHTS ARE APPROXIMATE.

ROSETTA® GRAND LEDGE 4-SIDED

PALLET OVERVIEW

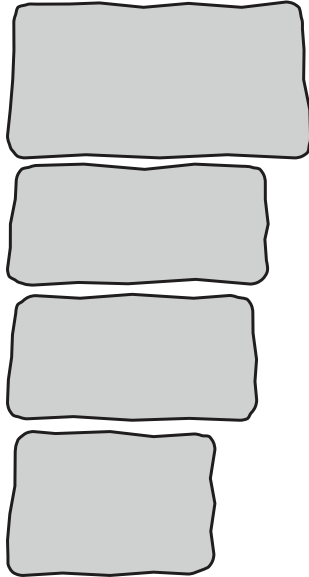

4 units / pallet
14.5 sq. ft. / pallet
3,950 lbs. / pallet
4 unique textures

SPECIFICATIONS



51" x 26" x 12"
1,280 lbs. / unit
1 unit / pallet

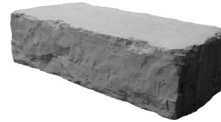

46" x 21" x 12"
970 lbs. / unit
1 unit / pallet



43" x 20" x 12"
840 lbs. / unit
1 unit / pallet



35" x 24" x 12"
850 lbs. / unit
1 unit / pallet

These 4-sided blocks are designed for use as corners, top blocks, and step returns.

LAYING PATTERNS

90° OUTSIDE CORNER

- 1 - 51" x 26" x 12"
- 2 - 35" x 24" x 12"
- 3 - 46" x 21" x 12"
- 4 - 43" x 12" x 20"

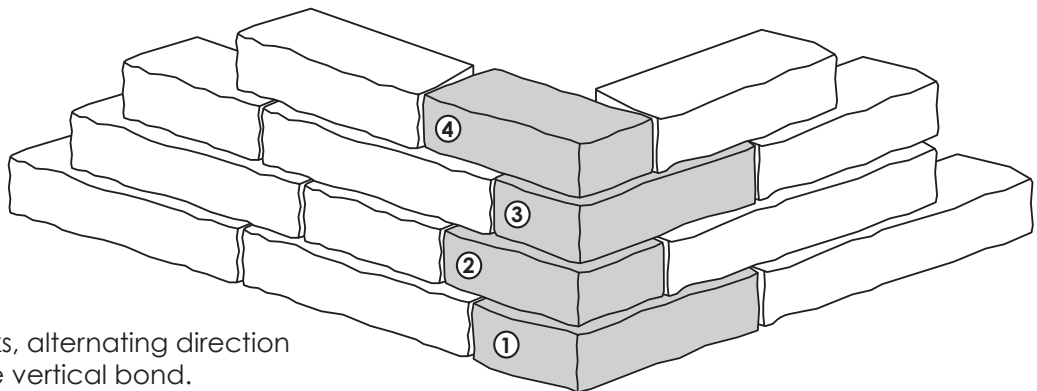

Overlap 4-Sided blocks, alternating direction each row to break the vertical bond.

NOTES



WETCAST
WARRANTY



OUTDOOR
LIVING



WALLS &
COLUMNS

COLOR SWATCHES AVAILABLE AT LAMPUS.COM • ALL WEIGHTS ARE APPROXIMATE.

APPLICATIONS