

ROSETTA® OUTCROPPING

SPECIFICATIONS

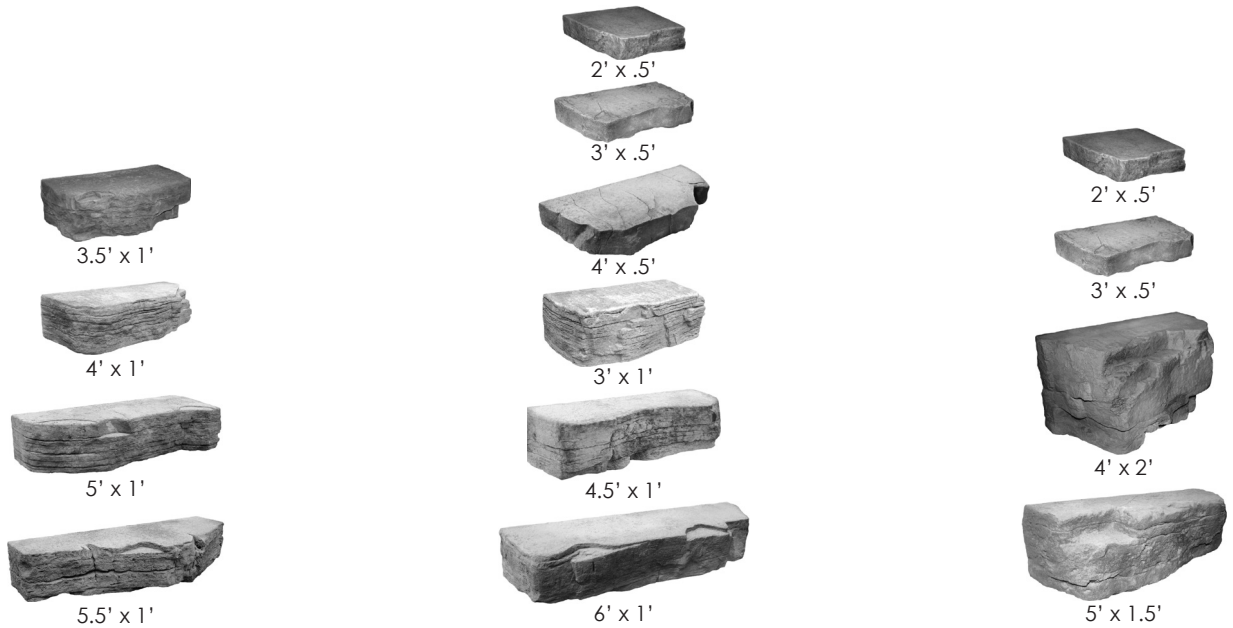

A PALLET:
 4 units / pallet
 18 face sq. ft. / pallet
 220 lbs. / sq. ft.
 4,000 lbs. / pallet

B PALLET:
 6 units / pallet
 18 face sq. ft. / pallet
 220 lbs. / sq. ft.
 4,000 lbs. / pallet

C PALLET:
 4 units / pallet
 18 face sq. ft. / pallet
 220 lbs. / sq. ft.
 4,000 lbs. / pallet

LAYING PATTERNS

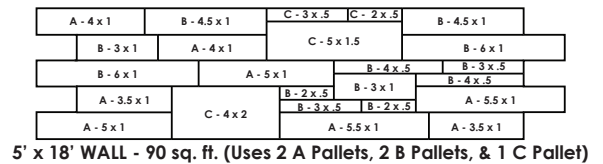
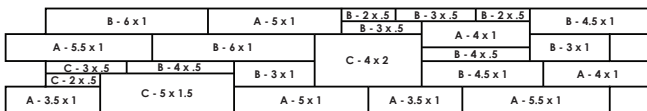
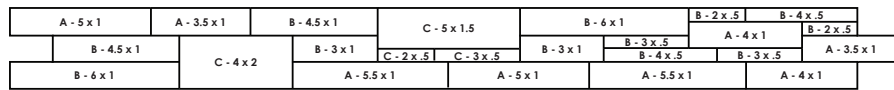
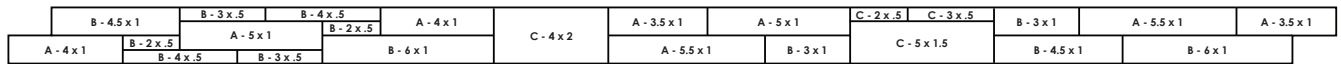

NOTES



CAP OPTIONS



APPLICATIONS



COLOR SWATCHES AVAILABLE AT LAMPUS.COM • ALL WEIGHTS ARE APPROXIMATE.

ROSETTA® OUTCROPPING CORNER

PALLET OVERVIEW

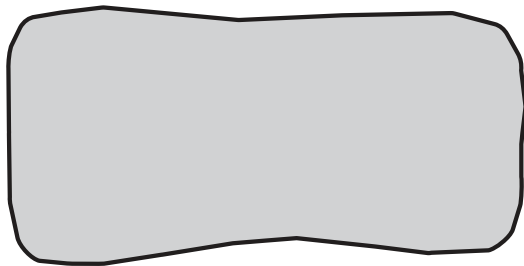
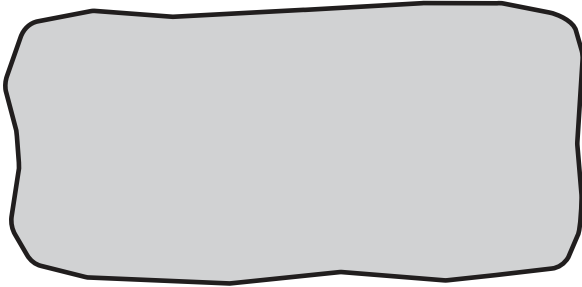

2 units / pallet
1,650 lbs. / pallet

SPECIFICATIONS



48" x 30" x 12"
1 unit / pallet



39" x 27" x 6"
1 unit / pallet

LAYING PATTERNS

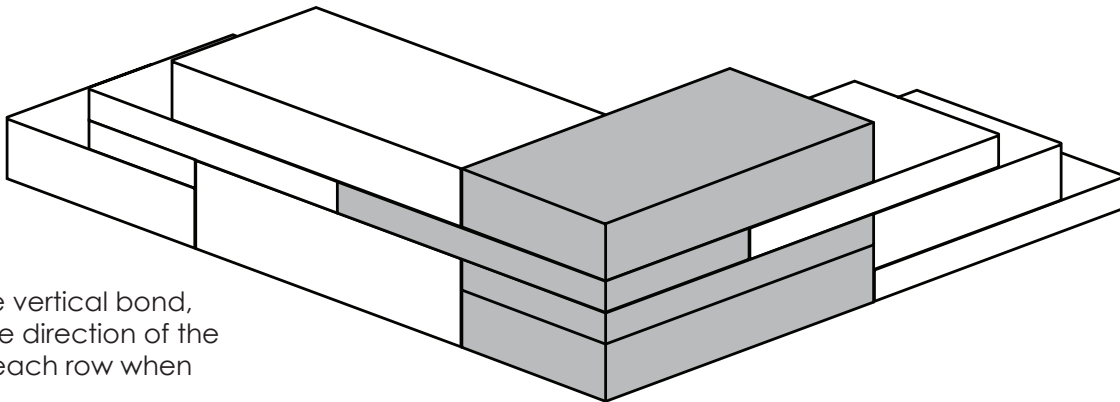

To break the vertical bond, alternate the direction of the corners on each row when possible.

NOTES



WETCAST
WARRANTY

CAP OPTIONS



IRREGULAR
STEPS

APPLICATIONS



WALLS &
COLUMNS

COLOR SWATCHES AVAILABLE AT LAMPUS.COM • ALL WEIGHTS ARE APPROXIMATE.